

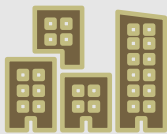

LI-OV10640-490-GMSL



Address:

48820 Kato Road
Suite 100B
Fremont, CA 94538
USA



Phone:

+1 (408)263-0988

Fax:

+1 (408)217-1960



Sales:

sales@leopardimaging.com

Support:

support@leopardimaging.com

INTRODUCTION

The LI-OV10640-490-GMSL is equipped with OmniVision CMOS 1/2.56" 1.3MP HDR image sensor OV10640, built-in ISP OV490 and Maxim GMSL serializer MAX96705. This camera outputs tuned YUV image data and supports HDR (High Dynamic Range) function.

KEY FEATURES

Sensor	OmniVision CMOS 1.3MP HDR Sensor OV10640
Optical Format	1/2.56"
Resolution	1280 (H) x 1080 (V) (active pixels)
Pixel Size	4.2 x 4.2 μ m
Data Format	Tuned YUV data Coax Serial real time streaming
Color / Mono	Color sensor
Frame Rate	30 fps @ 1280 x 1080
Build-in ISP	OV490
HDR (High Dynamic Range)	Supported
Lens	FOV H 55° / 115°
Serializer	Maxim MAX96705
Power Supply Range	5 ~ 17 VDC
Connector	FAKRA Z TYPE
Power Consumption	425 mA @ 5 VDC (1280 x 1080 @ 30 fps)
IP Rating	TBD
Operating Temp	-40°C ~ +85 °C
Storage Temp	-40°C ~ +85 °C
Weight	~ 45 g
Part#	LI-OV10640-490-GMSL-xxxH

APPLICATIONS

- Automotive Camera
- Camera Monitoring System
- Surround View System

DEFAULT IMAGING DIRECTION

- The logo "Leopard Imaging" is on the TOP

TOP (Default Imaging Direction)

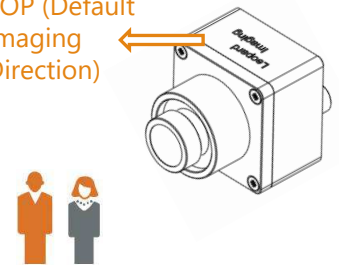

CABLE CONNECTOR

- Housing Connector FAKRA Z Type
- Cable Length: 3 meters
- Cable Part#: FAK-SMZSMZ-3M



DIMENSIONS: LI-OV10640-490-GMSL-055H

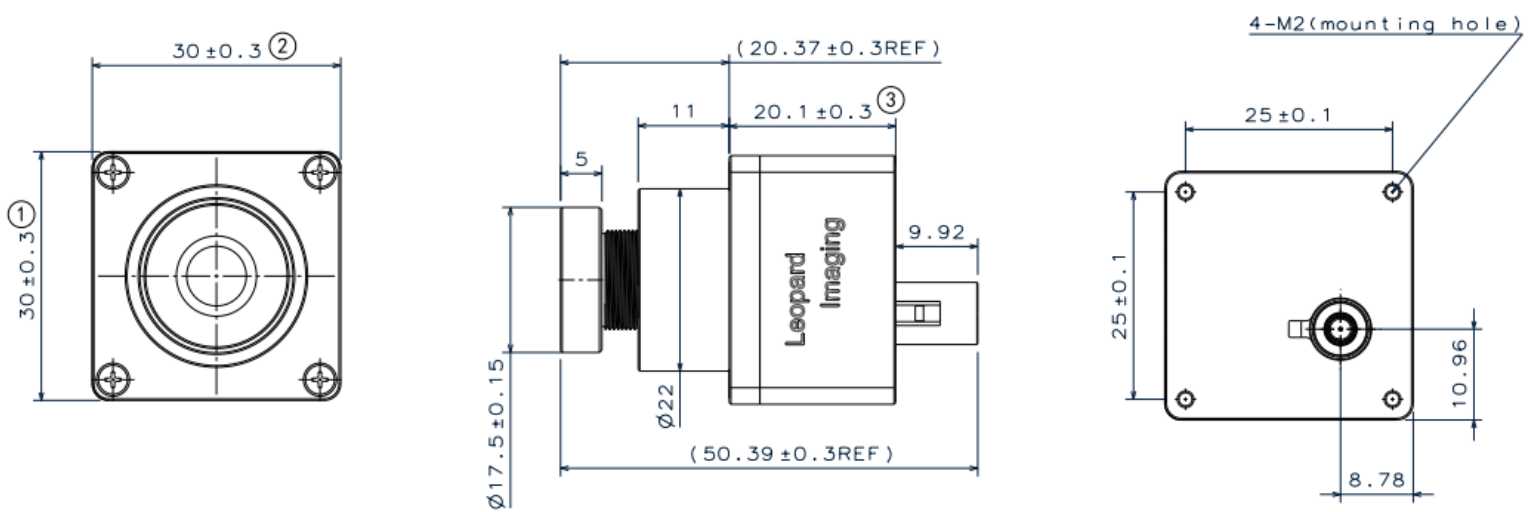

Note:

- \otimes marked are important sizes.
- Tolerance for others unmarked is ± 0.3 mm.

Unit: mm

DIMENSIONS: LI-OV10640-490-GMSL-115H

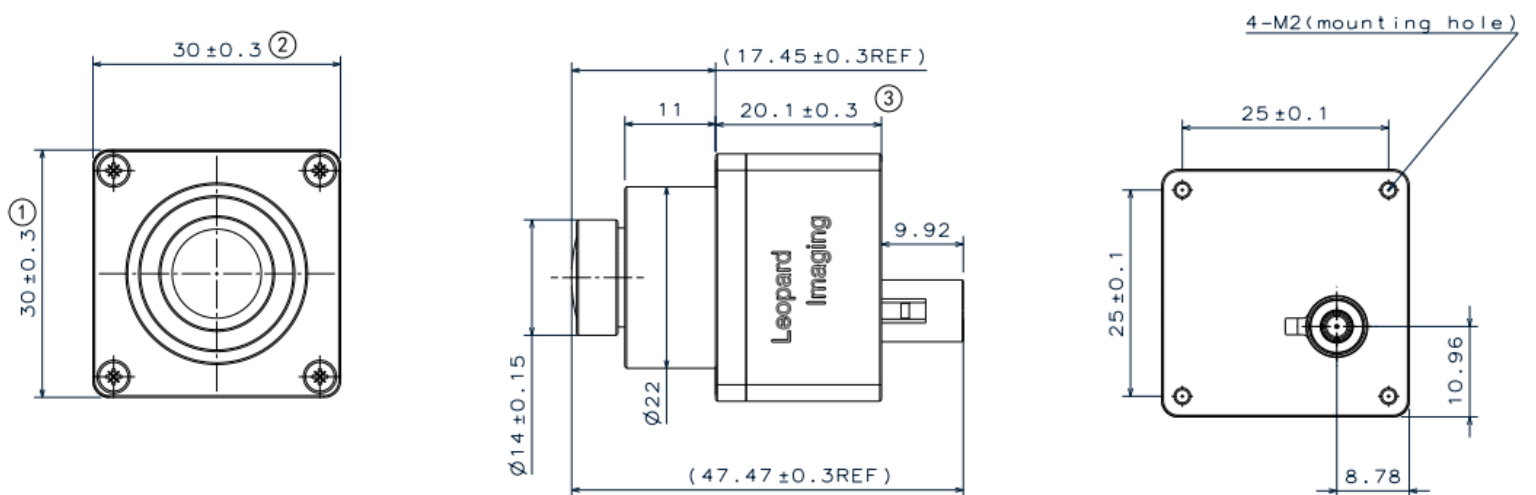

Note:

- \otimes marked are important sizes.
- Tolerance for others unmarked is ± 0.3 mm.

Unit: mm

BLOCK DIAGRAM

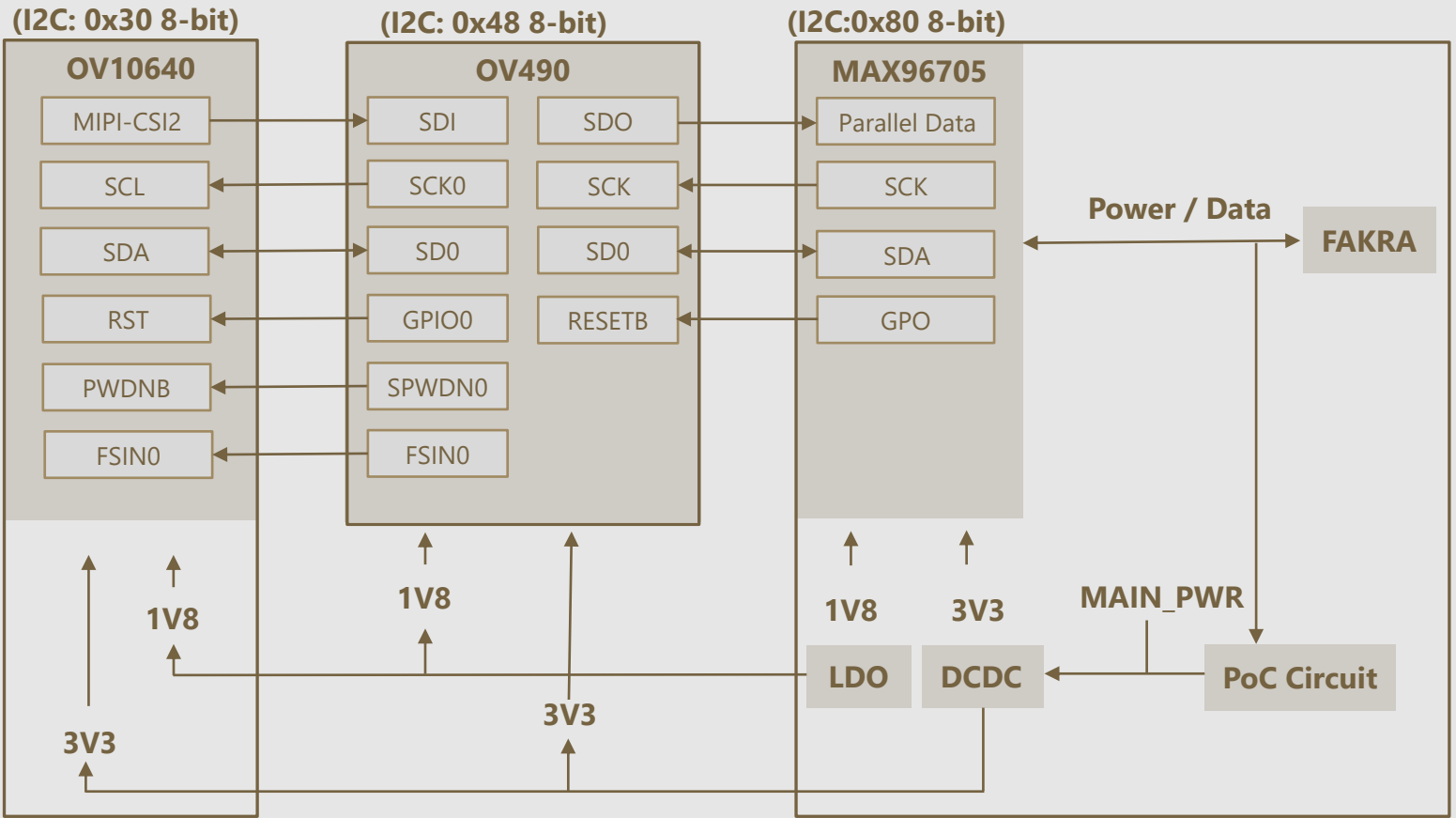

LENS SPECIFICATIONS

NOTE:

xxxH refers to 055H (FOV H 055°) or 115H (FOV H 115°)

LI-OV10640-490-GMSL-055H	LI-OV10640-490-GMSL-115H
	
Lens: M127B0618WR2	Lens: M128B02820WM12R1
Lens EFL: 6.0 mm	Lens EFL: 2.8 mm
Aperture, F/#: 1.8	Aperture, F/#: 2.0
Field of View (FOV): 75° (D) / 55° (H) / 46° (V)	Field of View (FOV): 150° (D) / 114° (H) / 96° (V)
Mount: M12	Mount: M12
IP Rating: IP67	IP Rating: IP67

USB3.0 CAMERA KIT

USB 3.0 EVA Module

LI-TESTER-NV

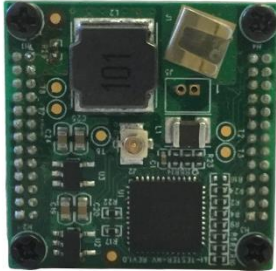

Front View

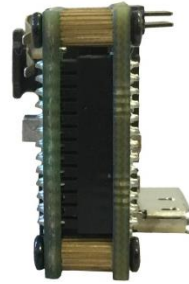

Side View

LI-USB30-CNTL

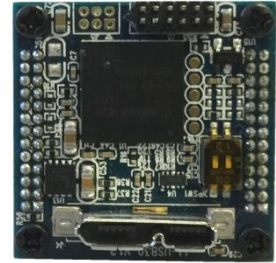

Back View

LI-OV10640-490-GMSL can connect to USB 3.0 EVA module as a USB 3.0 camera.
Part#: **LI-USB30-OV10640-490-GMSL-xxxH**

KEY FEATURES

- USB 3.0 Super Speed support
- YUV output without compression
- UVC compliant
- Allows customization
- USB + 5 VDC powered device
- Supports HDR
- Weight: ~ 86g
- Single Coax Cable transmits up to 12 meters PoC (Power over Cable)
- Resolution: 1280 x 1080 @ 30 fps
- Power consumption: 425 mA @ 5 VDC
- Compatible with Windows, Mac, Linux OS and other OS which have UVC drivers



BOM

#	Items	QTY
1	LI-OV10640-490-GMSL-xxxH	1
2	USB 3.0 EVA Module	1
3	3-Meter Fakra Cable	1
4	USB 3.0 Cable	1

SDK SUPPORTED

- Camera Tool Source Code in C#
- Capture & Display

● REVISION HISTORY

Revision	Description	Release Date
1.0	First release.	27 Jul 2017
1.1	<ol style="list-style-type: none">1. Updated power supply range.2. Updated storage temp.3. Added part "Default Image Direction."4. Replaced old power/system block diagrams with pinout connections diagram.	29 Apr 2022

48820 Kato Rd, Suite 100B, Fremont, CA 94538, USA

Phone: +1-408-263-0988

Fax: +1-408-217-1960

Email: sales@leopardimaging.com

Website: www.leopardimaging.com

