

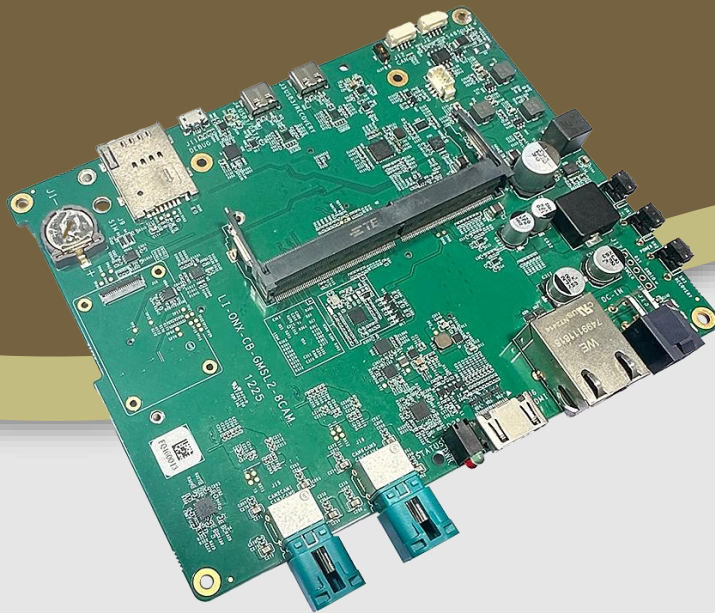

LEOPARD
IMAGING

LI-ONO-CB-GMSL2-8CAM



Address:

910 Auburn Ct
Fremont, CA 94538
USA



Phone:

+1 (408)263-0988

Fax:

+1 (408)217-1960



Sales:

sales@leopardimaging.com

Support:

support@leopardimaging.com

TECHNICAL FEATURES

- Carrier board for NVIDIA® Jetson Orin™ Nano
- Supports up to 8x Leopard Imaging FAKRA cameras
 - Mini Quad connector: 1206161400
- DeSerializer: 2x Maxim MAX96724
- 1 x Power interface
- 1 x HDMI connector
- 2 x USB Type-C interfaces:
 - 1 x USB 3.0 Type-C (data)
 - 1 x USB 2.0 Type-C (flashing port)
- 1 x USB2.0 Micro B debug interface
- 1 x RS485 interface
- 1 x CAN interface
- 1 x FAN interface
- 1 x RJ45 Gigabit Ethernet interface
- 1 x M.2 Key-M connector for SSD
- 1 x M.2 Key-E connector for WiFi
- 1 x M.2 Key-B connector for LTE, with MINI Sim card socket
- 1 x FPC connector for GNSS Extension board
- STATUS and PWR LED indicators included
- Recovery, RST and PWR buttons included
- Power supply range: 9 ~ 48 VDC
 - Note:** 12 VDC in default and auto power on.
- Operating temperature: -30°C ~ +85 °C
- Weight: ~144 g (Without SOM)

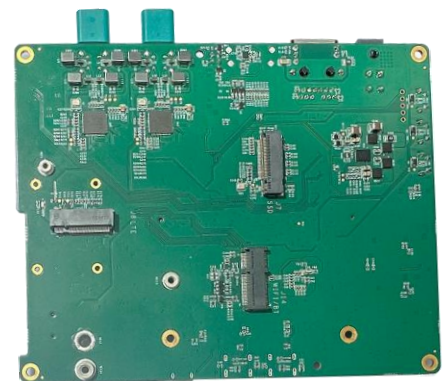

DIMENSIONS

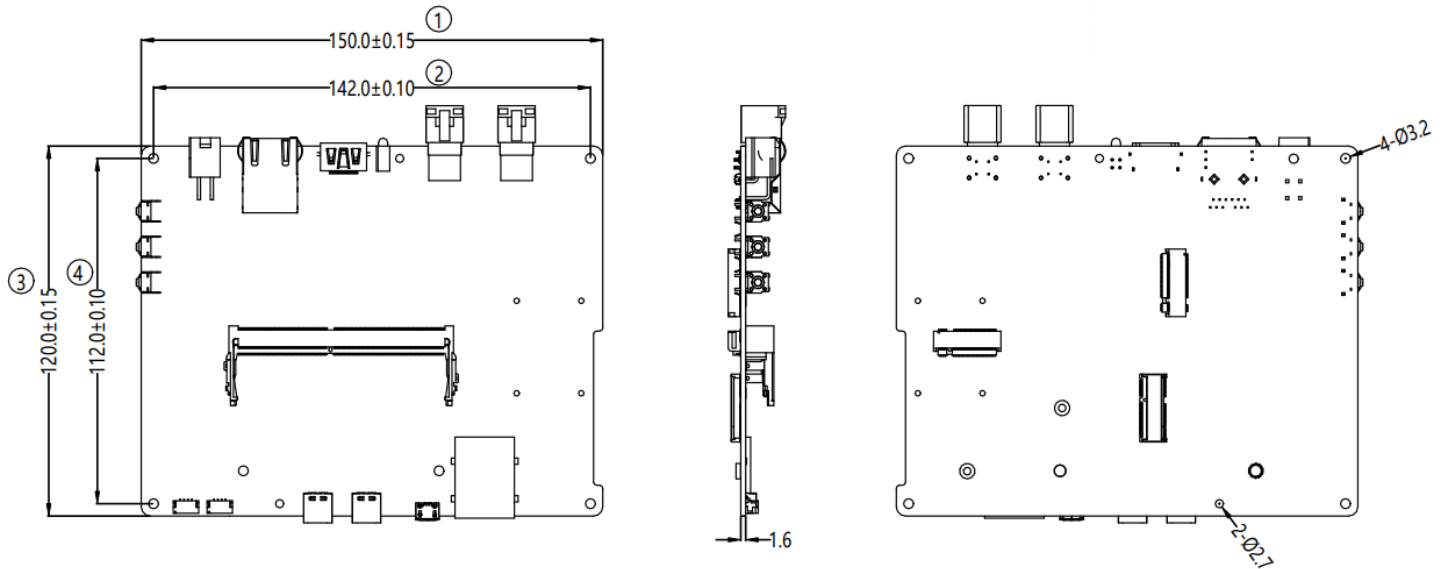

NOTE:

- ⊗ marked are important sizes.
- Tolerances for others unmarked - refer to the Tolerance Table.
- All materials are compliant with RoHS requirements.
- Unit: mm

TOLERANCE TABLE					
LENGTH TOLERANCE		CHAMFER TOLERANCE		ANGLE TOLERANCE	
Size X	Tolerance	Size X	Tolerance	Size X	Tolerance
0.5 < X ≤ 3	±0.1	0.5 < X ≤ 3	±0.2	X ≤ 10	±1°
3 < X ≤ 6	±0.1	3 < X ≤ 6	±0.5	10 < X ≤ 50	±30'
6 < X ≤ 30	±0.2	6 < X ≤ 30	±1	50 < X ≤ 120	±20'
30 < X ≤ 120	±0.3	X > 30	±2	120 < X ≤ 400	±10'
120 < X ≤ 400	±0.5			X > 400	±5'
400 < X ≤ 1000	±0.8				
X > 1000	±1.2				

BOM

#	Items	QTY	Unit
1	LI-ONO-CB-GMSL2-8CAM	1	Piece
2	12 VDC power supply: 1 x 12V power adapter + 1 x cable adapter	1	Set

NOTE:

- The 12 VDC power supply is for testing only.
- The Mini Quad FAKRA cable is not included. You can purchase via the following address:
<https://www.leopardimaging.com/product/accessories/cables/li-fcb-4t1-ss-2m-np-t1/>

RS485 Interface (J2)

- Part#: SM04B-GHS-TB
- Number of Positions: 4

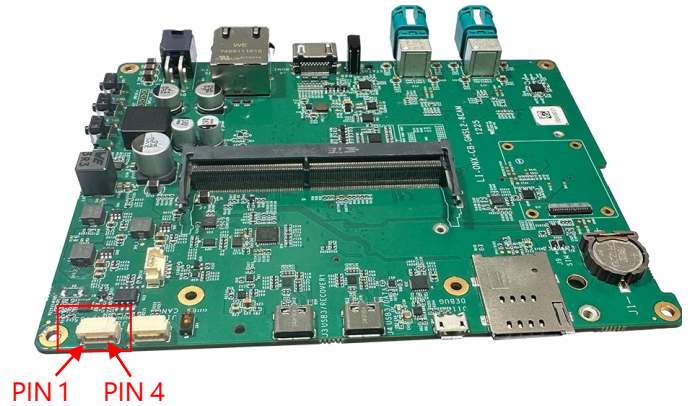

PINOUT

Pin No	Pin Name	Description	Pin Type	Voltage Level
1	A+	Differential output +	signal	-7V ~ 12V
2	B-	Differential output -	signal	-7V ~ 12V
3	Y+	Differential input +	signal	-7V ~ 12V
4	Z-	Differential input -	signal	-7V ~ 12V

CAN Interface (J12)

- Part#: SM04B-GHS-TB
- Number of Positions: 4

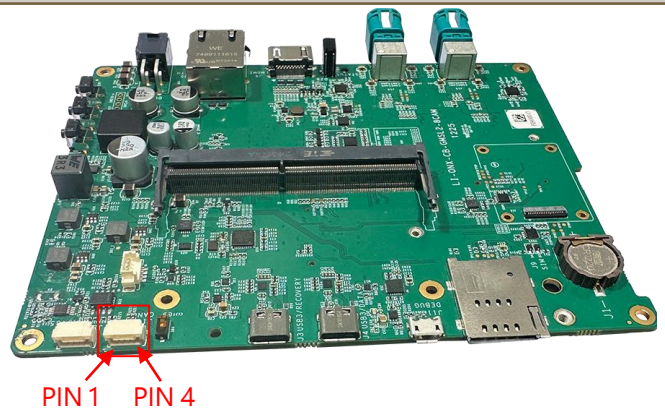

PINOUT

Pin No	Pin Name	Description	Pin Type	Voltage Level
1	VCC_5V	Power supply	Power	5V
2	CAN_H	Differential Input/output +	signal	0V ~ 5V
3	CAN_L	Differential Input/output -	signal	0V ~ 5V
4	GND	GND	-	-

FAN Interface

- Part#: 53398-0471//533980471
- Number of Positions: 4
- Pitch: 1.25 mm

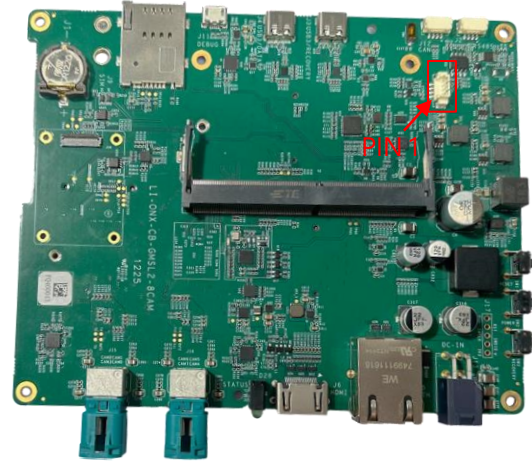

PINOUT

Pin No	Pin Name	Pin Type	Description	Voltage Level
1	GND	-	-	-
2	VDD_5V	POWER	5V Power Supply	5V
3	FAN_Tach	IO	Monitor the fan speed signal	1.8V
4	FAN_PWM	IO	Adjust the duty cycle to control the speed of fan	5V

Indicator Interface (D28)

Interface	LED Indicator
Logo	STATUS / PWR
Description	<p>STATUS: Constant shining in default. Blinking = Something wrong.</p> <p>PWR: Constant shining after power on.</p>

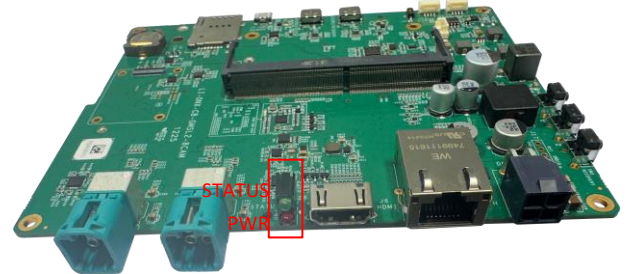

Power Supply Interface (J13)

- Part#: 1724480004
 - Number of Positions: 4
 - Power supply range: 9 ~ 48 VDC
- Note:** 12 VDC in default and auto power on.



PINOUT

Pin No	Pin Name	Description	Pin Type	Voltage Level
1	VCC_12V	Power supply	Power	12V
2	VCC_12V	Power supply	Power	12V
3	GND	GND	-	-
4	GND	GND	-	-

MINI SIM Card Interface (J9)

- Part#: SIM4065-8-1-15-00-A
- Card Type: Mini SIM

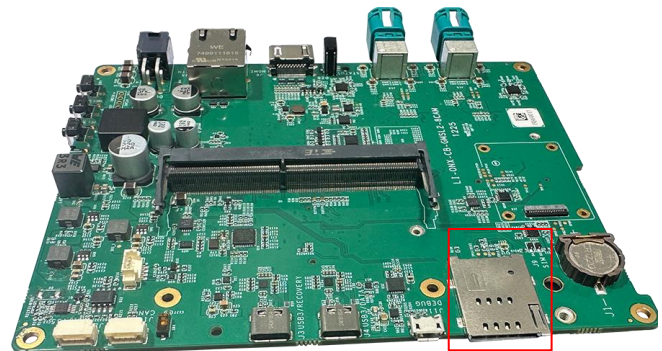

• LTE Interface (J8)

- Part#: 2199230-3
- Card Type: M.2 (NGFF) Mini Card (M.2 B)
- LTE: 4G or 5G

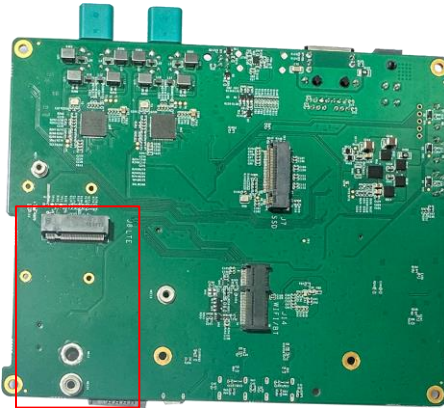

• WIFI & Bluetooth Interface (J14)

- Part#: 246411067401894E
- Card Type: M.2 (NGFF) Mini Card (M.2 E)
- Number of Positions: 67
- WIFI & Bluetooth: Wi-Fi 2.4GHZ & 5GHz, BT 5.0

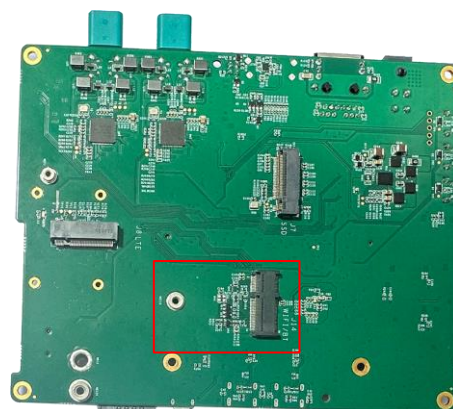

SSD Interface (J7)

- Part#: SM3ZS067U410AMR1000
- Card Type: M.2 (NGFF) Mini Card (M.2 M)
- Number of Positions: 67
- SSD drive capacity: TBD

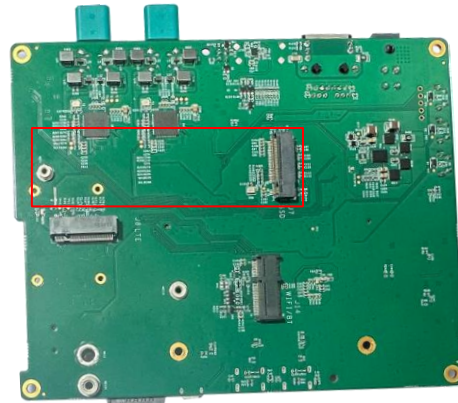

FPC connector for GNSS Extension board (J18)

- Part#: FH34SRJ-20S-0.5SH(99)

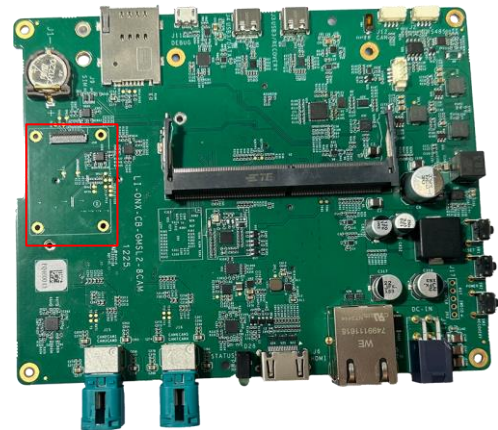

USB3.0 Type C Interface (J4)

- Part#: 12401899E412A
- Data port

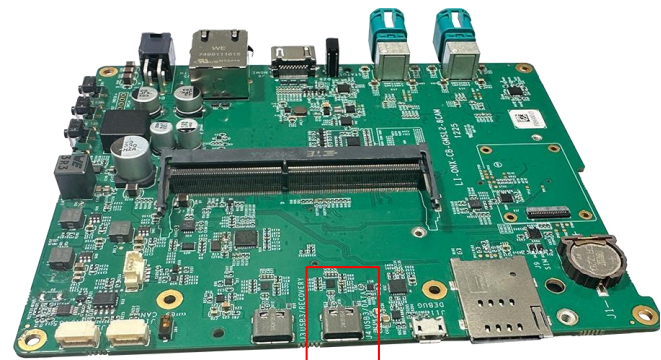

• USB3.0 Type C Interface (J3)

- Part#: 12401899E412A
- flashing port

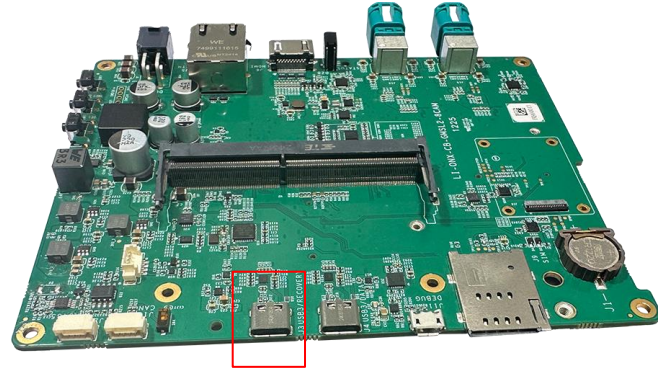

• MINI-FAKRA Quad Connector Interface (J15 / J16)

- Part#: 1206161400
- Number of Positions: 4



- REVISION HISTORY

Revision	Description	Release Date
1.0	First release.	21 May 2026

910 Auburn Ct, Fremont, CA 94538, USA

Phone: +1 (408)263-0988

Fax: +1 (408)217-1960

Email: sales@leopardimaging.com

Website: www.leopardimaging.com

