



* Copyright (c) 2024, Leopard Imaging Inc. All Rights Reserved.

Overview

This firmware is for LI-USB30-IMX728-9295 camera.
This firmware supports 3856 x 2176 @ 15 fps.
This camera doesn't include ISP and outputs raw data.

Platform	Camera
1 x LI-GMSL2-USB	1 x LI-IMX728-96717
Cable	Adapter/Carrier Board
1 x USB 3.0 Micro-B cable 1 x FAK-SMZSMZ Fakra cable	1 x 12VDC power supply

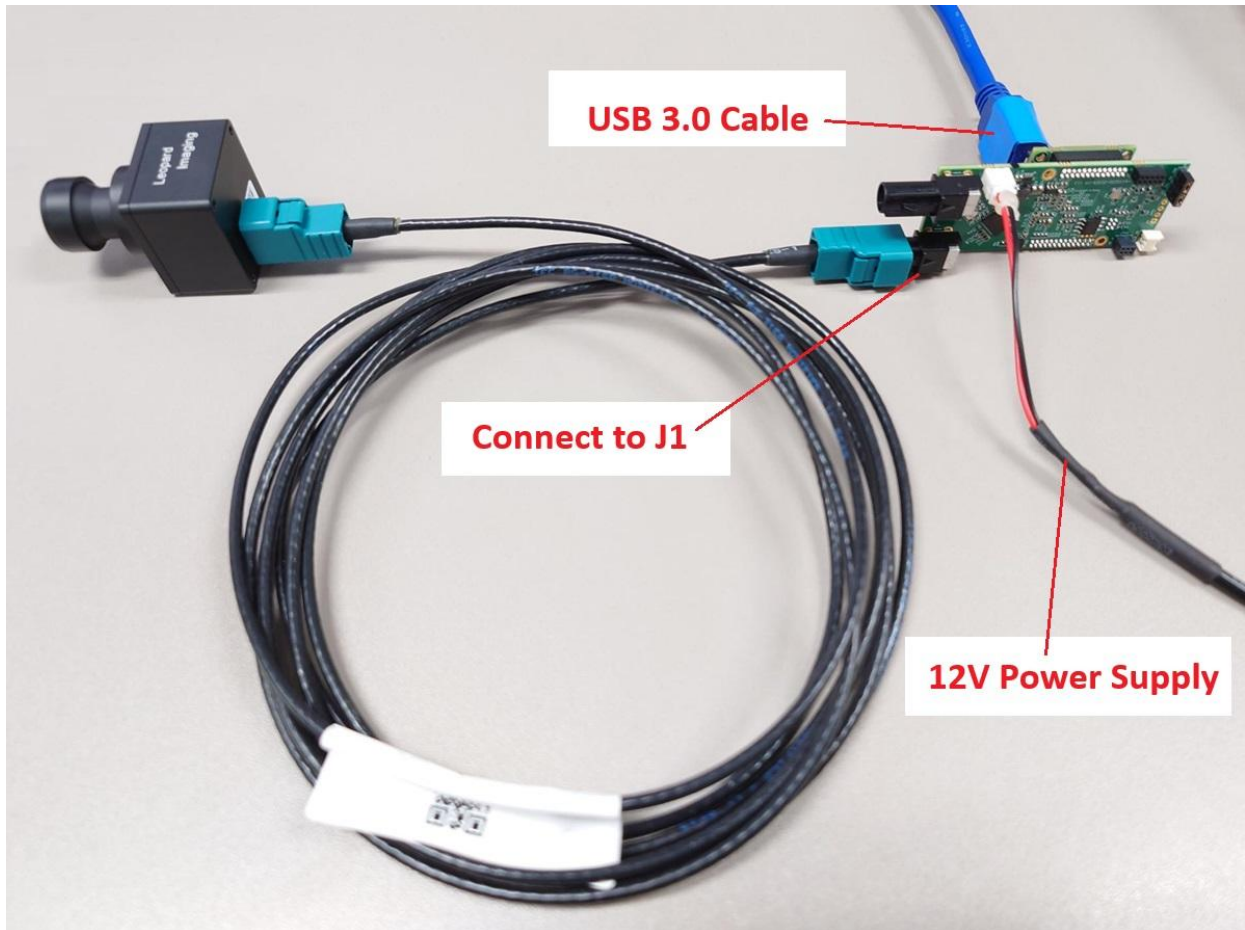



LI-USB30-IMX728-GM2B_ES3_User_Guide_20250124

Revision	SVN version	Release Date	Author	Tested By
2025_01_24		01/24/2025		Shelby Hache
Updates				
Revision	Description			Release Date
2025_01_24	First Release			01/24/2025
Known bugs				



Setup Procedure 1/3

- Hardware:

1. LI-IMX728-96717 x 1
2. LI-GMSL2-USB Tester x 1
3. FAK-SMZSMZ Fakra Cable x 1
4. USB 3.0 Micro-B cable x 1
5. LI-PS12-01 x 1

- Hardware Setup:

Connect the camera and USB 3.0 Tester board as the picture on the first page.

- Software:

This camera kit can be tested with any one of the below software:

1. Camera tool (Windows OS)

The Camera tool can be downloaded from the link below:

https://www.dropbox.com/s/8daqfypyhnbj5/CameraUSB30_3_2_20190622.7z?dl=0

It's better to use the 7-zip to uncompress the package:

<http://www.7-zip.org/download.html>

And install the software below on your PC:

https://www.dropbox.com/s/6usw140z8rqh2et/vcredist_x86.exe?dl=0

If needed, you can also download the camera tool SDK:

https://www.dropbox.com/s/j6ccl8cvt75gu2g/USB30_CameraTool_SDK_rev1440_20190622.7z?dl=0

2. Linux Camera tool (Linux OS)

The Linux camera tool can be downloaded from link below.

https://www.dropbox.com/s/4m2efo696px9739/linux_camera_tool-master_20190624.zip?dl=0

For how to install it, please refer to the README.md in below link. (the latest version of Linux camera tool may have an issue, so please use above Linux camera tool)

https://github.com/LI01/linux_camera_tool

Please follow the README.md in GitHub to install the Linux camera tool.

There are instructions online for how to install the OpenCV on Ubuntu OS.

Below is an example:

<https://www.learnopencv.com/install-opencv-3-4-4-on-ubuntu-18-04/>



Run Camera 1/3

- Camera Tool (Windows OS)

1. Connect the camera to port J1 of USB 3.0 Tester. (refer to picture in page 1)
2. Plug in the 12V power supply to USB 3.0 Tester.
3. Connect the camera to your PC (**USB3.0 port**) using the USB 3.0 cable.
4. Open camera Tool.

Please make sure to complete these steps in numerical order. Steps 2 and 3 cannot be reversed.

Color matrix:

You can adjust the color matrix in Options→ Configuration. Below is an example:

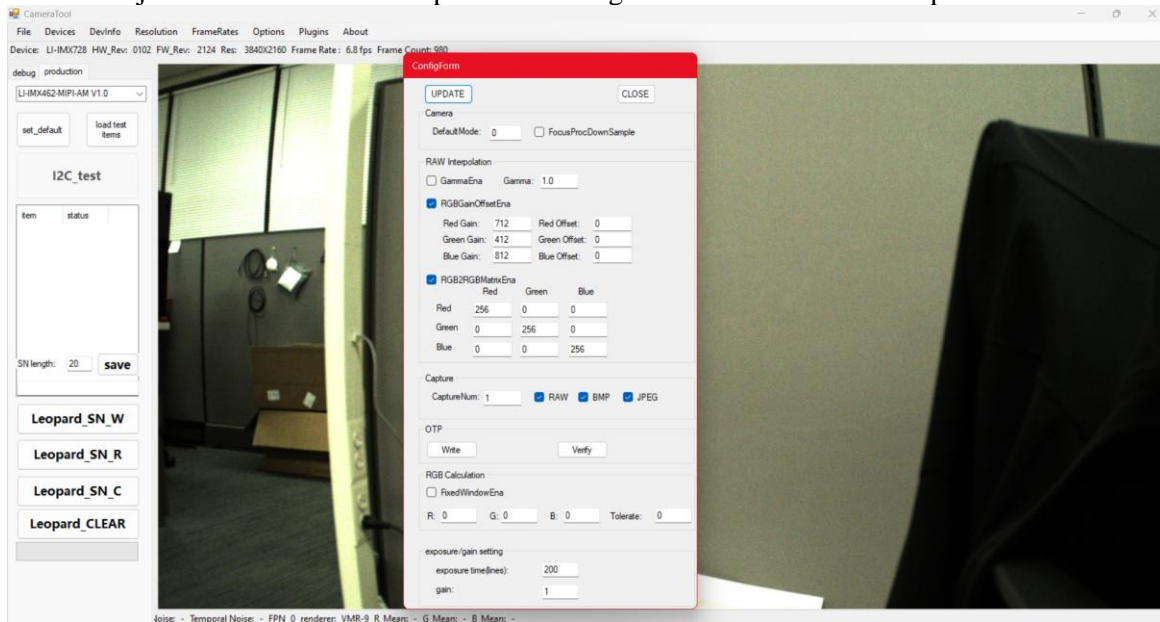

Register access function:

This camera supports register access function.

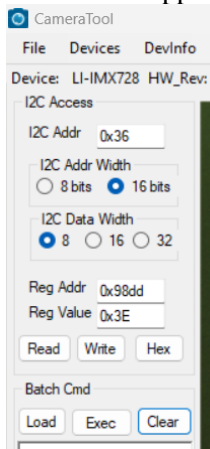

I2C: 0x36
 Exposure: 0x98dd / 0x98de
 Gain: 0x98f8

You can also use BatchCmd.txt file to write/read register.



Run Camera 2/3

Capture Image:

The images can be captured by clicking Options → CaptureImage. Two images (RAW and BMP) will be saved.

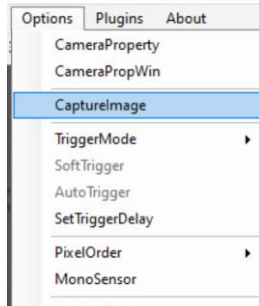

The raw image can be viewed by ImageJ.

<https://www.dropbox.com/s/fsvfmdy6s9ft03i/ImageJ.7z?dl=0>

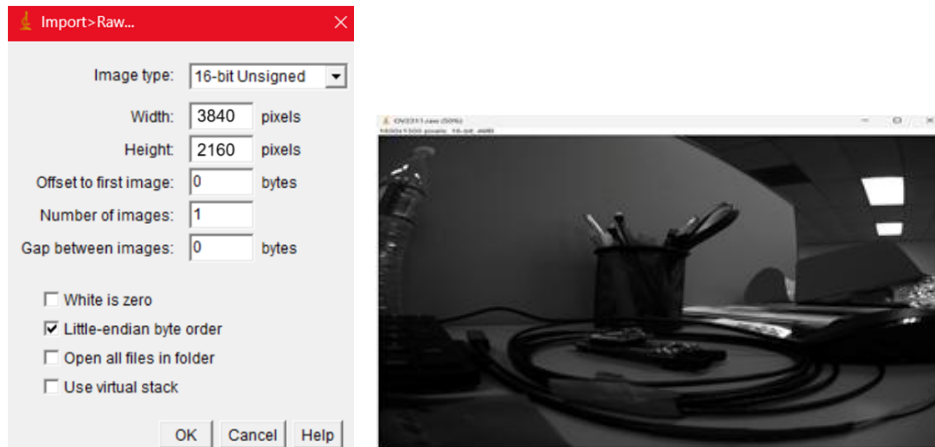

Raw-to-RGB function Supported.



Note: This camera tool supports Raw-to-RGB function which will reduce the display frame rate. You can click **Options** → **DisableDisplay** to get actual frame rate from the sensor. You can also use other regular software (like [AMcap](#)) to get higher frame rate, but the video will be green due to lack of Raw-to-RGB conversion function.



Run Camera 3/3

- Camera Tool (Linux OS)

1. Connect the camera to USB 3.0 Tester by aligning pins 1-24 (refer to picture in page 1)
2. Connect the camera to PC (**USB3.0 port**) through USB 3.0 cable.
3. Open a terminal and use the command “leopard_cam” to open the camera.

Set the camera as below to get better image quality.

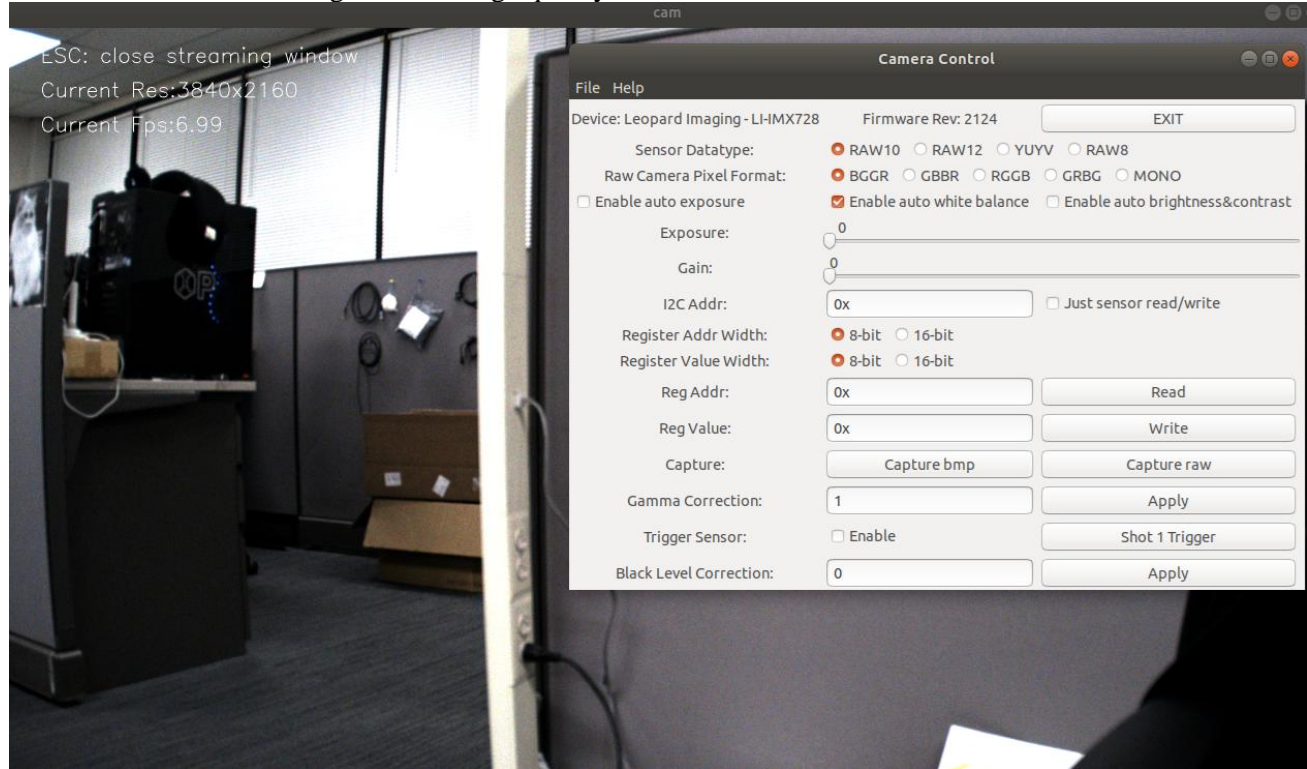

This camera tool can be used to write/read registers and capture Raw and BMP images.

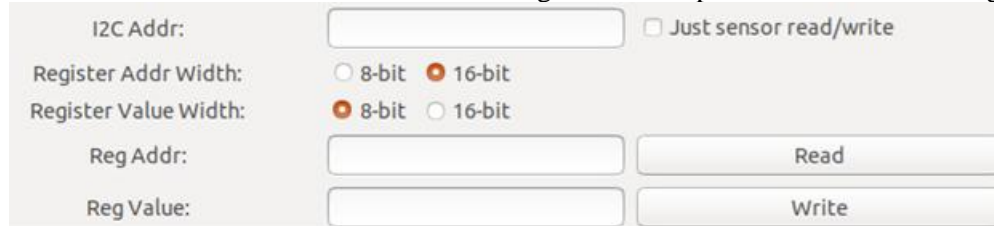



Note 1/3

This camera kit is pre-loaded with Firmware (in USB 3.0 Tester) and FPGA (in USB 3.0 Tester). If there is any new firmware from Leopard Imaging, you can refer to the instructions below to update them.

1. Firmware Update:

Please use the **LP_USB3_FirmwareUpdateTool** in the camera tool folder to update the firmware.

- 1) Click “Erase” to erase the old firmware.
- 2) Click “FW Update” button to select the lif file. (If the “FW_Update is unavailable, please install the WestBridge driver, check below)
- 3) The update process may take about 15 seconds.
- 4) If the process takes too long, please disconnect the USB and reconnect it to PC.
Then try the update tool again.

——Install WestBridge:

If the camera cannot be recognized after you update the firmware, and there is a device name “WestBridge” on the Device Manager, please download the driver from the link below and install it.

https://www.dropbox.com/s/4yx2p31b7qo2gix/WestBridge_driver.zip?dl=0

- 1) Right click on “WestBridge” and select Update Driver Software.
- 2) Choose browse my computer for driver software.
- 3) Click Browse, locate the driver at the downloaded and unzipped folder. (C:\temp\driver\bin\ for example)
If your PC has Win7 or later version, please select the folder “win7”.
- 4) Click next and complete the installation process.

After install the driver, please update the firmware again.



Note 2/3

2. FPGA Update:

FPGA Binary: mipi2cmos_4lane_raw10_v1.3_imx728_reverse_rst.rbt

1) Download the Lattice programmer tool software **Programmer Standalone 3.10 64-bit for Windows** from link below and install it to your PC.

<http://www.latticesemi.com/programmer>

2) Connect the HW-USBN-2A or HW-USBN-2B to J2 of LI-MAX9296-DESER board. Below is the pinout. You may need to build an adapter cable for the programmer tool and J2. J2 is a 1.27mm pitch interface.

Below pins in red need to be connected.

Only below pins in red need to be connected:

TI954 Board ← → HW-USBN-2B	TI954 Board ← → HW-USBN-2B
Pin1: V_3.3V ← → VCC	Pin2: SCK_D19 ← → TCK/SCLK
Pin3: N/A	Pin4: SDO_D18 ← → TDO/SO
Pin5: N/A	Pin6: SPI_CS_N ← → ISPEN/PROG
Pin7: GND ← → GND	Pin8: SDI_D20 ← → TDI/SI
Pin9: N/A	Pin10: CRESET_B ← → TRST

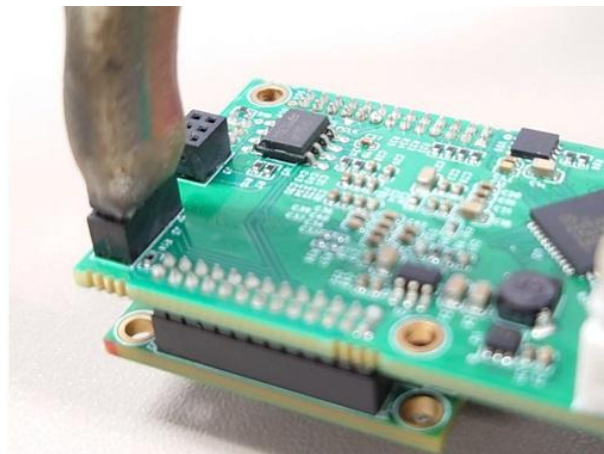
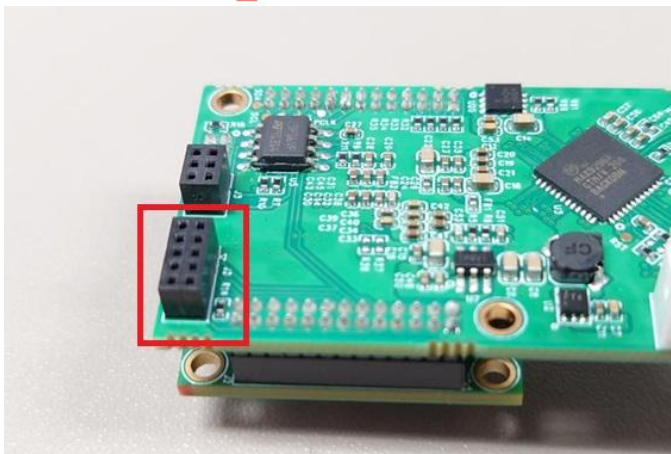
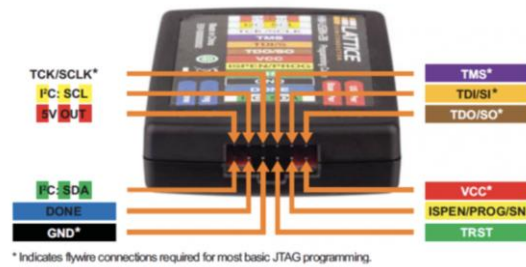
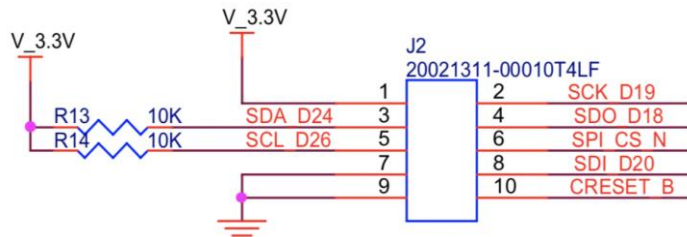



Note 3/3

- 3) Connect the USB3.0 Tester to your PC via USB 3.0 cable.
- 4) Open **LP_USB3_FirmwareUpdateTool** in the camera tool folder and click “Erase” to erase the firmware.
- 5) Open Lattice software (which you installed in 1). The Device name should be “LIF-MD6000”. Set the settings of “Operation” as below and click “OK”.

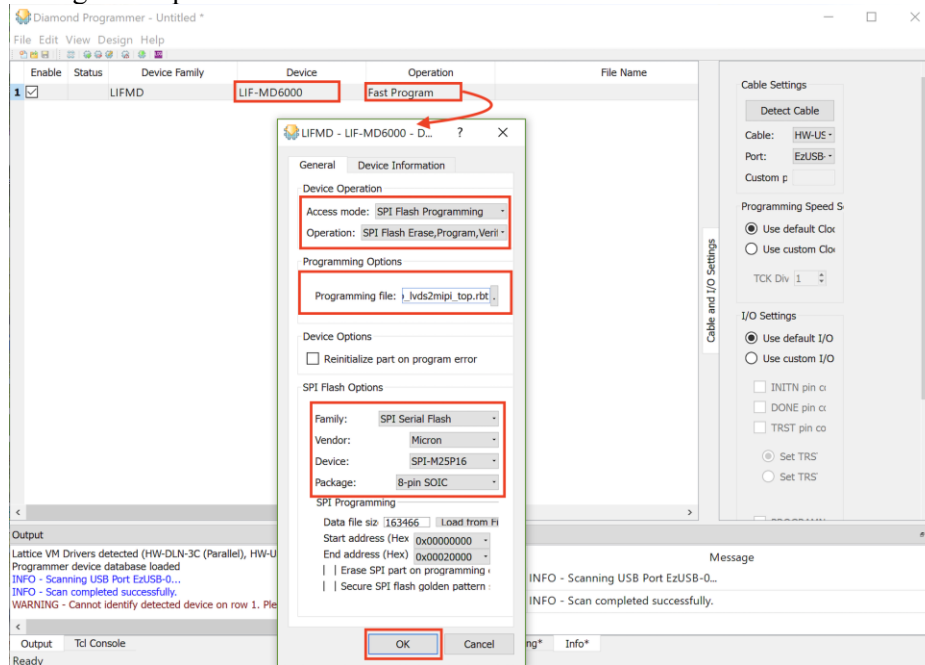

Important! If the GMSL2 board is V1.1 make sure to set Device: SPI-M25P16, if board is V1.3 make sure to set Device: SPI-M25P80

- 6) Click program icon.



- 7) It may take 9s to program the FPGA.



- 8) Go back and install the firmware. Refer to the “Firmware Update” section to install the firmware.